

Needles, Sutures, and Instruments

2

Jennifer Hasenyager Smith and Marian S. Macsai

Key Points

- Needle material, diameter, curvature, and point style all contribute to needle function and should be considered relative to the goal of suturing and tissue type when selecting a needle.
- Suture material and diameter determine strength, handling, adsorbability, knot security, and tissue reactivity. Together with the tissue type and goal of suturing, these characteristics should be considered when selecting suture material.
- Instruments used for microsuturing should be of the appropriate size and style to facilitate safe, effective suturing in light of the specific needle, suture, and tissue involved.
- New technology in suturing instrumentation includes suture swaged to needles of the same or smaller diameter, suture coated with bioactive glass and antibacterials, and microincision instruments for intraanterior chamber suturing.

2.1 Introduction

Information about suture materials and needles is important, as inappropriate use of a material or needle type can lead to wound breakdown or tissue injury. For example, following trauma, the use of an absorbable suture to repair a scleral rupture can lead to wound dehiscence a few weeks after the repair, and the use of a cutting or reverse-cutting needle on the sclera can lead to choroidal or retinal injury at the time of repair. The surgeon faces several decisions when closing a wound. These decisions include choice of suture and needle, placement of sutures, and type of knot.

2.2 Needles

Prior to 1959, eyed needles were commonly used in the United States for ocular suturing [48, 61]. These needles worked in a similar fashion to the common clothes sewing needles in current use. The use of an eyed needle threaded with suture resulted in a double thickness of suture being pulled through the needle tract; however, only a single-thickness of suture was left tied in the incision. This was problematic in that the needle tract was resultantly larger in diameter than the suture and was prone to leakage. The needle swage, or permanent attachment of the suture to the needle at the time of manufacture, which was patented in 1914 [35], eventually came into popular use and allowed for improved techniques in ocular suturing (Tables 2.1 and 2.2).

2.3 Needle Characteristics and Selection

(See Table 2.1.)

Although the performance of a needle is determined by its shape and its composition, needles are typically described in manufacturers' catalogs by shape but not by metallurgical composition. The characteristics that define a specific needle type include curvature (1/4, 3/8, or 1/2 circle), chord length, and radius (Fig. 2.1); linear needle length, wire diameter, and point cutting edge (Fig. 2.2).

There are two basic styles of needle swage (attachment of suture to needle end) in use for the small needles used in microsuturing, laser drilling, or channel fixation. Laser drilling forms a hole in the trailing end of the needle into which the suture is secured. Channel fixation involves the use of a tool that forms a planed cut that is half the thickness of the needle wire along the trailing end of the needle. The cut is approximately four times the length of a laser-bored hole, and the suture is fixed to a depression in the cut area. The process results in a groove and an unevenly rounded surface at the needle end. A disadvantage of the channel-fixed needle is that the suture can be loosened or the swage

Table 1. Basic surgical needle types and their characteristics. References [29, 32, 40, 42, 59]

Needle Type	Bite	Cross section	Side cutting Y/N	Tissue tract	Procedure(s)	Comment
1/4, 3/8 circle	Large/shallow					
1/2 circle	Short/deep					
Spatula		trapezoid	Y	Intralamellar plane	Lamellar keratoplasty, cataract incisions, strabismus surgery, etc	
Standard cutting		Triangle, point up	Y	Tracks superficially	Scleral grafts, corneal sutures, etc	Tough tissues, full-thickness bites. Sharper than reverse cutting.
Reverse cutting		Triangle, point down	Y	Tracks deeply	Scleral grafts, corneal sutures, etc	Tough tissues, full-thickness bites
Standard cutting/beveled edge		Triangle, point up	Y	Tracks superficially	Scleral grafts, corneal sutures, etc.	Tough tissues, full-thickness bites. Sharper than standard cutting or reverse cutting. More bending than non-beveled.
Taper-point		circle	N	Smaller than trailing suture	Trabeculectomy, iris suturing	Not good for tough tissues
Tapercut		Tip: triangle; Body: round	Y	Smaller than trailing suture	Trabeculectomy	Combination of reverse-cutting and taper point. Penetrates tissues more easily but still watertight.

Table 2.2. Common microsurgical needle characteristics

Model	Circle	Needle Type	Wire (mm)	Length (mm)
CIF-4	¼	Taper Point	0.20	13.34
PC-7	¼	Taper Point	0.23	13.34
BV 100-4	3/8	Taper Point	0.10	5.11
STC-6	Straight	Spatula	0.15	16.00
SC-5	Straight	Spatula	0.15	16.15
CTC-6	¼	Spatula	0.15	11.99
CTC-6L	¼	Spatula	0.15	14.00
CS160-6	3/8	Spatula	0.15	5.33

can be deformed when grasped by a needle holder at the swaged area. Laser-drilled swages have less wire bulk removed during manufacture and have a smoother trailing needle end. They are therefore less easily deformed when grasped near the trailing end [53]. The relative biomechanical performance of channel-style and laser-drilled needles was compared in two Ethicon needles in a standardized grading system [3]. It was shown that laser-drilled needles were both easier to pass through a test membrane and less likely to deform or break than channel-style needles. The authors of that study recommended laser drilling for all needles.

The properties of an ideal surgical needle have been summarized as: (1) sufficiently rigid so that it does not bend; (2) long enough so that it can be grasped by the needle holder for passage and then be retrieved without damage to its point; (3) of sufficient diameter to permit a slim-point geometry and a sharp cutting edge, resulting in a tract large enough to allow the knot

to be buried; and (4) as nontraumatic as possible [43]. Optimal surgical needles should also be composed of materials that resist dulling and permanent deformation during passage through tissue. At the same time, the material should not be so rigid that it is brittle and likely to fracture easily if stressed.

Needles can additionally be evaluated in terms of resistance to bending and ductility. A needle's resistance to bending can be objectively measured with a standardized procedure that generates a graph of force required to reversibly and irreversibly bend a needle [2, 14]. Factors affecting the resistance to bending of a needle include needle diameter, needle material, and the manufacturer. Needle ductility refers to the amount of deformation that a needle can withstand without breaking [18]. Superior ductility grading was seen in needles made from American Society for Testing and Materials (ASTM) 45500 alloy and finished with the electrohoning process [1, 14].

In studies of sharpness, needles with longer, more narrow cutting edges and needles made from ASTM alloy 45500 were the sharpest [14, 57]. The standard cutting edge and reverse-cutting edge needles both have triangular cross sections, with two lateral cutting edges that can influence needle sharpness [9]. The third cutting edge of a standard cutting needle is located on the concave surface (also referred to as the inner, or top, surface) of the curved needle. The reverse-cutting needle has its third cutting edge on the convex surface (outer, or bottom, surface) of the needle (Fig. 2.2). In standardized sharpness comparisons, the standard cutting needle was found to be sharper than the reverse-cutting needle [59], and a modified standard cutting edge needle with beveled edges and correspondingly narrower cutting edges (Fig. 2.3) was found to have further enhanced sharpness both in vitro through a synthetic membrane and in vivo for suturing skin lacerations in the emergency room [29]. The narrower cutting

angle along the concave surface facilitates tissue penetration [32]. However, it has also been recently shown that in comparison with triangular and diamond-shaped tips, a bevel tip causes more bending and is more easily affected by tissue density variations [40].

Taper-point needles (cardiovascular or BV needles) are frequently used to close conjunctiva when a watertight suture line is desired, such as in trabeculectomy [27]. Taper-point needles with two combined radii of curvature are also available and provide greater accuracy to a controlled depth and length of bite than does a curved needle with a single radius of curvature [15]. A modification of the taper-point needle, the Tapercut (Fig. 2.2F), combines a short reverse-cutting tip with a taper-point body. The resulting needle is sharper and initially penetrates tissue more easily than a taper point, and is still able to create tighter needle tracts with more watertight closures than would a reverse cutting needle. In order to create the smallest possible ratio of needle-to-suture diameter, polypropylene suture material can be extruded to create a tapered swage end of significantly smaller diameter than the remainder of the suture, allowing a channel swage to a needle of minimal diameter ([60]; Fig. 2.4).

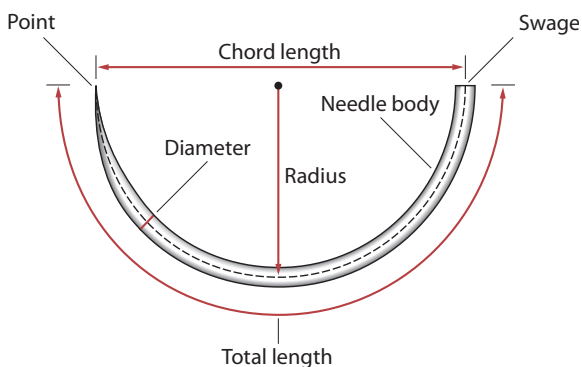

Fig. 2.1 Specifications terminology for surgical needles. (Reprinted from Steinert RF. *Cataract Surgery, Techniques, Complications, and Management*, 2nd Edition, p 53. © 2004, with permission from Elsevier)

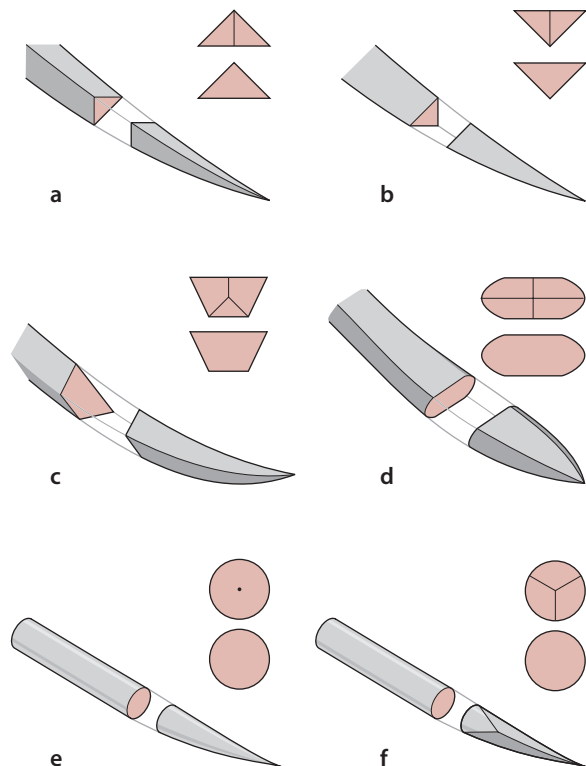

Fig. 2.2 Schematic illustrations of surgical needle types. **a** Conventional cutting needle, **b** reverse cutting, **c, d** Spatula needles, **e** Taper-point needle, **f** Tapercut needle. (Reprinted from Steinert RF. *Cataract Surgery, Techniques, Complications, and Management*, 2nd Edition, p 52. ©2004, with permission from Elsevier)

2.4 Sutures

In the history of general surgery, many materials have been used as sutures, including horsehair, linen, silver wire, and twine. Early improvements in suture technology included the development of catgut and silk

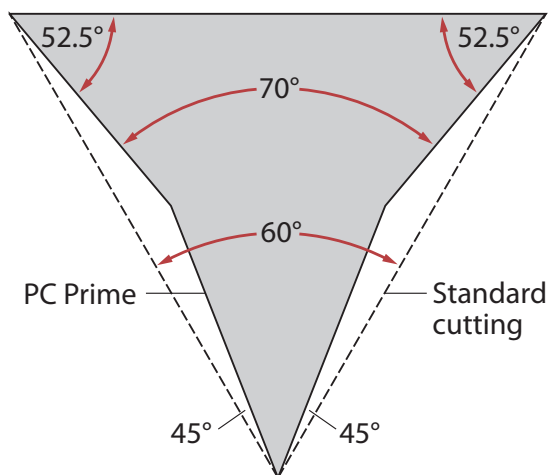

Fig. 2.3 Standard cutting needle (dotted outline) and PC prime needle (solid outline). (Reprinted from Steinert RF. *Cataract Surgery, Techniques, Complications, and Management*, 2nd Edition, p 53. ©2004, with permission from Elsevier)

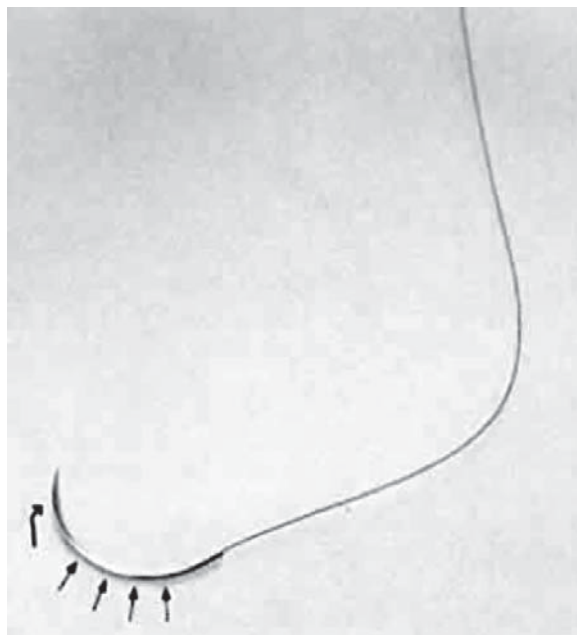

Fig. 2.4 Suture and needle used for ophthalmic microsurgery. The head of the needle (curved arrow) determines the tract through which the suture passes. The handle or shaft (straight arrows) is the area by which the needle is held. The most posterior aspect of the suture is the area of the swage. Grasping the needle in this area can result in loosening of the suture

sutures [18, 19]. Refinements continued, including sterilization of silk sutures and treatment of catgut with chromic and carbolic acids to increase the duration of the suture holding strength in tissue from a few days to weeks [21]. Synthetic materials such as nylon and polyester became available in the 1940s. More recently, additional synthetic materials such as polyglycolic acid, polybutester, polyglactin, and polydioxanone have been used to make suture.

Suture material is classified either as adsorbable or nonabsorbable. Absorbable suture is defined as suture that loses most of its tensile strength within 2 months. The time it takes for a suture to be degraded in tissue varies by type of material. Absorbable sutures include polyglactin (Vicryl), collagen, gut, chromic gut, and polyglycolic acid (Dexon) materials. Polyglactin (Vicryl) has a duration of about 2 to 3 weeks. Although it has a high tensile strength, this tensile strength decreases as the suture mass is absorbed. Polyglactin is available in braided or monofilament varieties. Collagen suture has a shorter duration and a lower tensile strength than does polyglactin. Gut has duration of approximately 1 week, with an increased amount of tissue reactivity. Because gut is composed of sheep or beef intestines, an allergic reaction is possible. Chromic gut differs from plain gut in that it has a longer duration of action, typically 2 to 3 weeks. It has less tissue reactivity than plain gut.

A nonabsorbable material such as nylon is much more slowly broken down over many months, and polypropylene, and other modern synthetics are much more inert. Nonabsorbable sutures include nylon, polyester (Mersilene), polypropylene (Prolene), silk, and steel materials. Nylon suture has high tensile strength, but loses between 10 and 15% of the tensile strength every year. It is a relatively elastic material and causes minimal tissue inflammation. Both polyester and polypropylene sutures are thought to be permanent, have high tensile strength, and similarly do not cause much tissue reaction. Unlike these sutures, silk has a duration that is less permanent, about 3 to 6 months. Silk is often associated with a greater amount of tissue inflammation as well. The advantage of silk suture, however, lies in the fact that it is very easy to tie and handle, as well as that it is well tolerated by patients in terms of comfort. Finally, steel sutures are used for permanent placement. Their advantages include high tensile strength and inability to act as a nidus for infection. (See Table 2.3 for a summary of commonly used suture materials and their characteristics.)

Table 2.3 Commonly used surgical sutures and their characteristics

Material	Trade name example	Absorbable (Y/N)	Retains tensile strength	Inflammation	Handles well (+/-)	Comment
Gut	–	Y	4–5 days	+	+	
Chromic gut	–	Y	14–21 days	++	–	Very stiff
Polyglactic acid	Vicryl	Y	14–21 days	+	+/-	Less tensile strength than Dexon
Polyglycolic acid-braided	Dexon	Y	14–21 days	+	–	Maintains strength longer than gut or Vicryl, stiff
Polyglycolic acid-coated	Coated Vicryl	Y	14–21 days	+	+	Better knots and passage than braided
Polydioxanone	PDS	Y	6+ weeks	+/-	–	Minimal inflammation, very stiff
Polytri-methylene carbonate	Maxon	Y	6+ weeks	+/-	+	Stronger than PDS, better knot tying than Vicryl
Nylon	Ethilon	N	90% strength at 1 year	–	+/-	Occasional inflammatory response, inherent memory requires additional knot throws for security
Silk: virgin	–	N	3–4 months	+/-	+	Low tensile strength, variable inflammatory responses
Silk: braided	–	N	3–4 months	+/-	+	Less inflammatory than virgin silk
Polypropylene	Prolene	N	Years	–	+/-	Slippery—requires extra throws on knots
Braided polyester	Mersilene, Dacron	N	Years	–	+	Less slippery, equal strength to mono filaments
Coated polyester	Ethibond	N	Years	–	+	Less tissue drag
Polybutester	Novafil	N	Years	–	+	Elasticity accommodates edema of tissues, lasts longer than nylon

References: [5, 7, 8, 11, 13, 16, 17, 23–26, 28, 30, 33, 36, 37, 44–47, 49–51, 55, 56, 62, 65]

2.5 Suture Characteristics and Selection

Ideal characteristics for suture material in ophthalmic microsuturing vary depending on the tissue being sutured and the purpose for the suture. The avascular nature of the cornea and sclera presents a unique circumstance for suturing in that the lack of blood flow, and therefore the lack of cellular components required for wound healing, leads to prolonged wound healing times and diminished tissue strength at the incision site [20, 64]. Therefore, a strong and long-lasting suture that does not incite chronic inflammation is re-

quired for suturing cornea or sclera. Nylon (10-0) has become the most commonly used ophthalmic suture for closing limbal and corneal wounds. Nylon biodegrades and loses its tensile strength beginning at 12 to 18 months. When a more permanent suture is needed, as with suturing of the iris or transscleral fixation of an intraocular lens (IOL), 10-0 Prolene is used frequently. Prolene is difficult to work with, somewhat difficult to tie because of its memory, and has been shown to erode through both sclera flaps and conjunctiva. The iris is vascular; however, it typically does not show any healing response, is extremely delicate, and can generate little force or tension on a suture. The optimal suture

for the iris is therefore a material that is inert so as to last indefinitely and cause no intraocular inflammation, but also easily manipulated in the challenging intraocular space. The conjunctiva is very thin and very vascular and may exhibit a too-vigorous healing response, resulting in scar formation that can be both functionally and cosmetically unacceptable. It is therefore useful to use quickly degraded adsorbable suture or inert non absorbable suture for conjunctiva. For example, conjunctiva that is not under tension usually can be closed with a collagen (8-0) suture. However, when the conjunctiva is under tension, an 8-0 Vicryl suture would be more appropriate because of the longer duration of action of the Vicryl suture.

The purpose for which the suture is needed is also an important aspect of suture selection. For example, when closing incisions or lacerations, the purpose of the suture is to maintain tissue apposition and structural integrity until the healing and scarring response of the tissue has restored the tissue to a suitable degree of strength and stability. In ocular suturing, issues of watertightness are often important as well. Alternatively, when securing a device such as an IOL or a scleral buckle, the purpose of the suture is to permanently maintain the device in the desired location with minimum tissue reaction and maximum stability. Suture characteristics such as tensile strength, tissue reaction, handling (ease of knot tying, tendency to kink, pliability, etc.), adsorbability, and size (diameter of suture) are among the considerations when choosing a suture for a given application [17, 38, 39].

2.6 New Technology

Ongoing materials research has resulted in new materials and manufacturing processes such as melt spinning of a block copolymer to create a monofilament fiber that is comparable in strength to monofilament suture materials in current clinical use but is less costly to produce [6]. Other new bioabsorbable suture materials include self-reinforced poly-L-lactide (SR-PLLA), which has been found to have longer retention of tensile strength as compared with polyglyconate and polydioxanone in vitro [31] and lactide-epsilon-caprolactone copolymer (P[LA/CL]), whose degradation is not affected by changes in pH [58].

Recent advances in suture technology include coating of polyglactin sutures with both bioactive glass and antibacterials. Polyglactin suture with bioactive glass coating has been shown to develop bonelike hydroxyapatite crystal formation around the suture when immersed in simulated body fluid [10, 12]. The hydroxyapatite layer can become part of a 3-D scaffold for further tissue engineering applications [10, 12, 52]. Silver im-

pregnation of the bioactive glass coating can impart antibacterial properties to the suture as can coating of the suture with triclosan [10, 54]. Recent investigations of silk fiber, which is far more inert than previously believed [41], have revealed that it, too, has potential for tissue engineering by addition of growth or adhesion factors to silk's multitude of different side chains [4].

2.7 Suture Size

An integral aspect of suturing is knot construction. The suture material, suture gauge, and tying style all influence the ultimate size, strength, and stability of a knot. In ophthalmic microsuturing, it is desirable to minimize knot size while maximizing knot strength and stability. Large knots on the ocular surface are irritating to the patient and can cause inflammatory reactions [63]. Large knots are also difficult to bury and may distort incisions or adjacent tissues, resulting in induction of astigmatism or other adverse effects. It has been shown that suture gauge more greatly influences final knot size than the number of throws does. For example, adding two additional single throws to a suture knot of a given gauge increases knot mass by a factor of 1.5, whereas doubling the suture gauge increases knot volume by a factor of 4 to 6 [63].

2.8 Instruments

Microsurgery requires fine control of instruments with minimal tendency for instrument slippage. Some microsurgical instruments have a serrated flat handle, others have a rounded knurled handle, and still others have a round serrated handle (Fig. 2.5). The serrated or knurled areas allow a firmer grasp and tighter control of the surgical instrument. An instrument with a round, knurled handle may be rotated in the fingertips, allowing greater flexibility during some procedures while maintaining a firm grasp with little tendency to slip.

No surgical instruments should be grasped like a pencil, resting in the crotch between the thumb and forefinger (Fig. 2.6). In ophthalmic microsurgery, longer instruments are rested against the first metacarpophalangeal joint, with the thumb and first two fingers encircling the handle. Stability is achieved by resting the side of the fifth finger on the periorbital facial structures. This method of holding surgical instruments allows rotation of the instrument between the fingertips, by flexing the fingers or by rotating the wrist. Great mobility is necessary when using a needle holder (needle driver) to pass a needle through tissue. When the surgeon en-

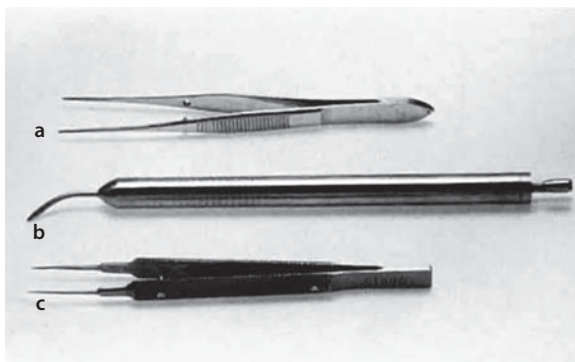

Fig. 2.5 Three surgical instruments with three handle styles. **a** Flat serrated handle. **b** Round serrated handle. **c** Round knurled handle

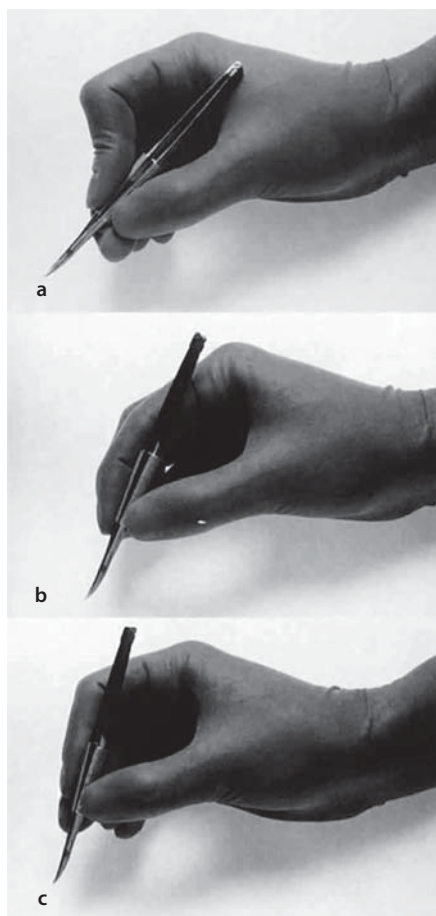

Fig. 2.6 **a** Surgical instrument held like a pencil, resting in the crotch between the thumb and forefinger. No surgical instruments should be held in this manner. **b** Longer surgical instrument held resting against the first metacarpophalangeal joint of the first finger, with the thumb and the first finger encircling the handle. This position allows rotation of the instrument between the fingertips and flexion of the fingers or wrist. **c** The surgical instrument is held between the thumb and fingertips of the second and third digits. It is not resting on the first metacarpophalangeal joint. This position allows for a perpendicular positioning of the instrument on the eye

counters resistance from the tissue, it is usually necessary for the surgeon to twist the wrist or apply counter pressure on the tissue at the exit site of the needle.

Holding surgical instruments correctly provides the surgeon with increased flexibility and mobility. The serrations on the handle, regardless of style, allow the surgeon to hold the instrument lightly but firmly. With the level of precision of currently available instruments, it is never necessary to grasp an instrument tightly. The tendency to grasp instruments tightly must be avoided because it decreases flexibility and increases fatigue of the hand and forearm muscles.

The instruments required for microsuturing vary depending on the specific surgical circumstances. In general, suturing requires the use of a needle holder, tissue forceps, and suture scissors. Suture-tying forceps are often helpful as well, but may not be necessary if the tissue forceps have a tying platform.

2.9 Needle Holders

Needle holders vary in size, shape, and mechanism. When suturing under the microscope, very small sutures and needles are employed, and therefore, a correspondingly small needle holder should be used. If the needle holder is too large in relation to the needle, the jaws of the needle holder may deform the needle in its grasp, or the needle may be difficult to grasp and pass through tissue.

A non-locking needle holder should be used when suturing under the microscope so that the locking and unlocking action does not cause uncontrolled movement of the needle holder tip, which is undesirable in the microscopic field.

The jaws of the needle holder should be flat on the inner surface rather than toothed or grooved so that the delicate shafts of the small needles are not inadvertently deformed or twisted when grasped. Needle holder tips may or may not be tapered and can be straight or curved. However, tapered and curved jaws facilitate grasping of suture ends if the needle holder is used for tying (Fig. 2.7).

When grasping a needle with a needle holder, the needle should be gripped approximately one third of the way forward from the swage end. One should avoid gripping the needle close to the swage end because the suture can be inadvertently detached from the needle swage. Additionally, the cross section of any needle is round in the area of the swage, and the flat jaws of the needle holder will not be able to stably grip the needle—allowing for uncontrolled rotation of the needle during passage through the tissue. A firm but gentle grip of the needle well forward of the swage will allow for optimal control.

The needle itself should be held in the jaws of the needle holder perpendicular to the long axis of the needle holder and approximately one third to one half of the way back between the tips and the jaws of the needle holder (Fig. 2.8). Curved needle holders should be used with jaws curving upward.

2.10 Tissue Forceps

Before using forceps to grasp tissue, the surgeon must have a clear understanding of the mechanism by which the instrument holds tissue and the extent of damage caused by the instrument. In ophthalmic suturing, two different instruments are used to grasp tissue, smooth and toothed forceps.

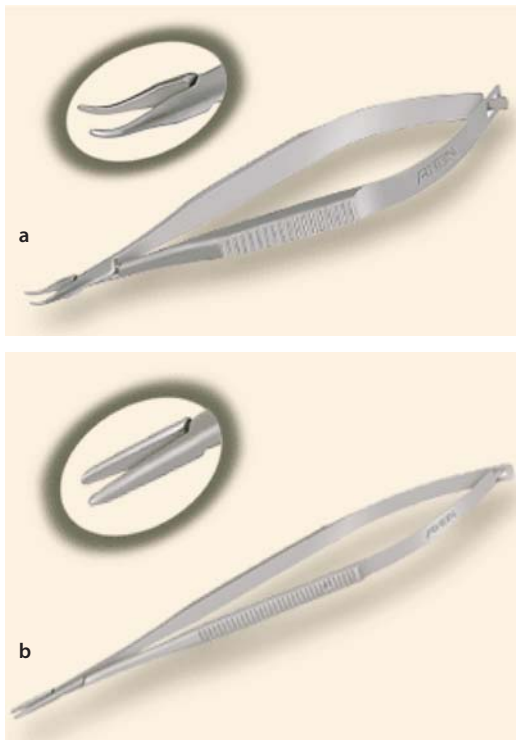

Fig. 2.7 Nonlocking needle holders. **a** Curved (Rhein). **b** Straight (Rhein)

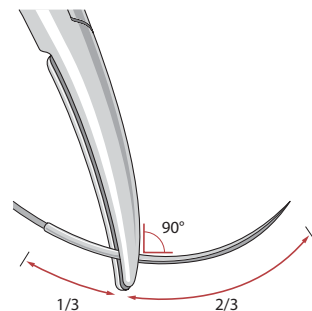

Fig. 2.8 Needle holder is shown grasping a surgical needle approximately two thirds of the way from the head of the needle to the suture. The needle is seated properly in the needle holder at a 90° angle

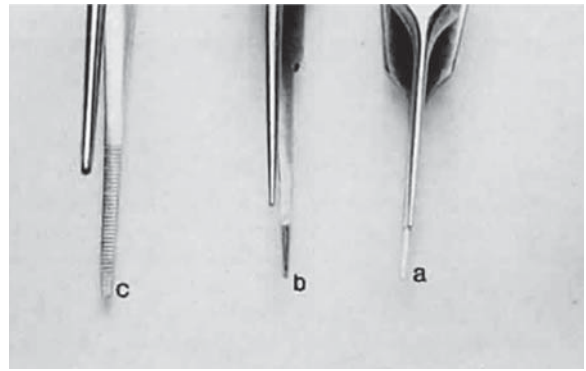

Fig. 2.9 Three different smooth forceps. On the right are absolutely smooth forceps (a). In the middle are grooved forceps (b). On the left is an instrument with a serrated platform (c). The instrument on the right is used to grasp fine suture, whereas the instrument on the left is more commonly used to handle conjunctiva or thin tissue that can conform to the ridges of the serration

Smooth forceps (i. e., forceps without teeth) should be used when handling delicate tissues (Fig. 2.9). For example, smooth forceps are necessary when working with tissue that must not be punctured or damaged, such as the conjunctiva during a trabeculectomy. Serration of the grasping surface provides increased friction without damaging the tissue. It is effective in handling the conjunctiva because the conjunctival surface can conform to the ridges of the serration. Crisscross serrations permit traction in all directions, resulting in minimal tissue slippage.

Tissue forceps for ocular microsuturing must be small at the tips, have teeth for a firm hold, and have a tying platform proximal to the toothed ends for handling of suture. There are multiple variations on the shape of the handles, length of the forceps, and configuration of the tips. All small-toothed forceps with tying platforms can be used for both tissue fixation and suture manipulation during suturing and tying.

Toothed forceps can have teeth at a 90° angle (surgical forceps) or angled teeth (mouse-tooth forceps, see Fig. 2.10). An example of a surgical toothed forceps is 0.12-mm forceps; an example of a forceps with angled teeth is the O'Brien forceps. Microscopic examination of the instrument from the side determines tooth design. Toothed forceps are needed for tough tissue, such as the cornea or sclera, whereas soft tissues, such as the iris or conjunctiva, are better handled with smooth forceps (see Fig. 2.10). Surgical toothed forceps damage delicate tissue. However, these forceps exert a high degree of resistance, which is necessary for manipulating tougher tissues. Forceps with angled teeth seize tissue lying in front of the end of the blades. This forceps grasps a minimal amount of tissue and produces minimal surface deformation, frequently without penetrating the tissue. The angle-tooth forceps can be useful

for grasping the cornea during suture placement. If the teeth are dull or bent, the forceps are ineffective.

The number and orientation of the teeth on a forceps affect the stability of fixation and tissue damage. Teeth angled at 90° provide good fixation, but greater tissue damage than teeth angled at 45° (mouse-tooth forceps). Increasing the number of teeth also increases the degree of tissue fixation. One example is the Thorpe corneal fixation forceps, in which the 90° teeth are in a 2×3 configuration. The Thorpe corneal fixation forceps have been modified with 45° -angled, 0.12-mm teeth in a 2×3 configuration, thus allowing for increased stability of tissue fixation, with limited tissue damage. When driving or passing a needle through tissue that is fixed with toothed forceps, the forceps should be held such that the needle enters the tissue on the side of the forceps with the greatest number of teeth. In other words, when Thorpe corneal fixation forceps are used, the needle should pass through the tissue on the edge that is secured by three teeth. This maneuver limits the twisting of the tissue as the needle

is advanced through the tissue. Finally, an alternative is the Pierse-type forceps, which have no teeth but have a small hollow area immediately posterior to the tip. This hollow area allows for tissue displacement instead of the tearing of tissue that occurs with sharp-toothed forceps. A widely used microsuturing tissue forceps are the 0.12-mm Castroviejo toothed forceps (Fig. 2.11). If one attempts to use a serrated forceps on rigid material, such as the sclera, only the tips of the serration will hold the tissue, reducing the contact area and the effectiveness of the forceps. Therefore, toothed forceps must be used to grasp the sclera effectively (Fig. 2.12).

Toothed grasping forceps should never be used to directly handle a needle, because the fine teeth of the forceps may be damaged by the steel needle. The forceps may be used to indirectly handle the needle by grasping the suture near the needle swage. Additionally, toothed grasping forceps should be used with care when handling suture—if the suture is grasped with the teeth rather than by the tying platform, the suture can be inadvertently cut.

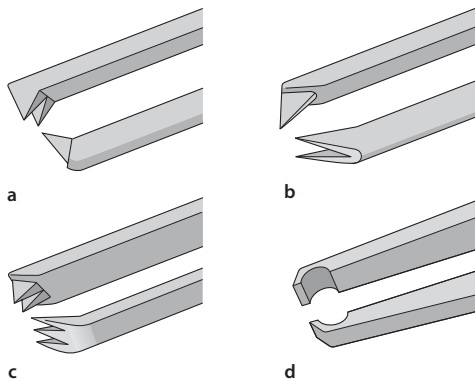

Fig. 2.10 Tooth forceps may be identified by the angle of insertion of the teeth. **a** Forceps with teeth at a 90° angle. **b** Mouse-tooth forceps with angled teeth. **c** Thorpe corneal fixation forceps with 45° angled, 0.12-mm teeth in a 2×3 configuration. **d** Pierse-type forceps with no teeth but with a small hollow area immediately posterior to the tip

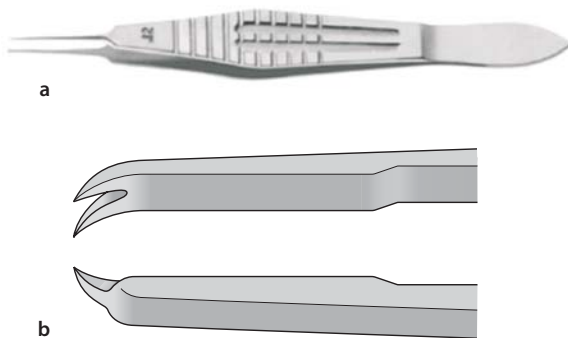

Fig. 2.11 **a** Castroviejo 0.12-mm tissue forceps (Asico). **b** Detail of grasping toothed tips (Asico)

2.11 Tying Forceps

In contrast to tissue forceps, tying forceps should have no teeth and have smooth tips (no ridges or serrations) that are thin and tapered. The forceps tips should close

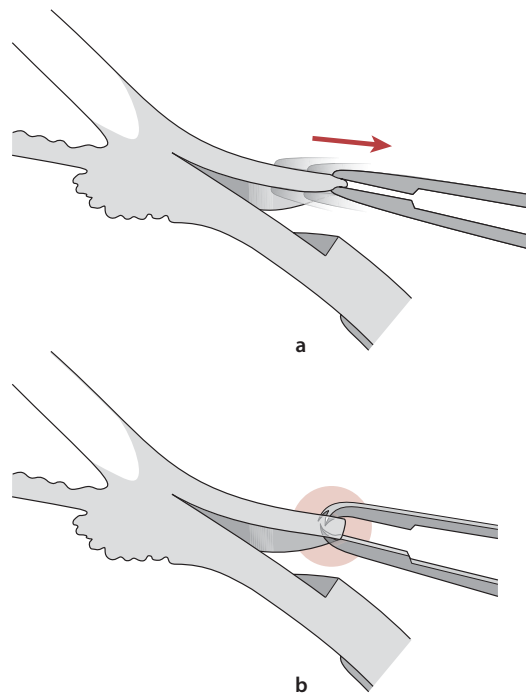

Fig. 2.12 When smooth forceps are used to grasp rigid sclera, the forceps slip. **b** Toothed forceps are more effective to grasp rigid tissue such as the sclera or cornea

very precisely in order to securely but gently grasp small-gauge (e. g., 10-0) suture material (Fig. 2.13). The tips may be curved, angled, or straight, and the handle may be of varying length and shape.

Tying forceps are used for suture tying, suture rotation, and various other handling of suture. Overcompression of the forceps will cause the tips to gape (Fig. 2.14). When rotating sutures, it is critical to use only tying forceps with smooth jaws, because any forceps with teeth will likely cut the newly placed suture. Be-

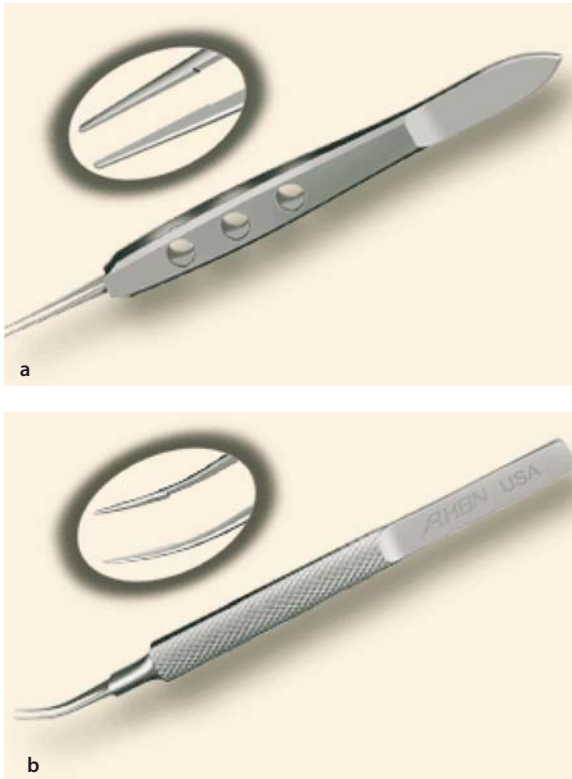

Fig. 2.13 Tying forceps (Rhein). **a** Jaffee straight tying forceps. **b** Tenant curved tying forceps (Rhein)

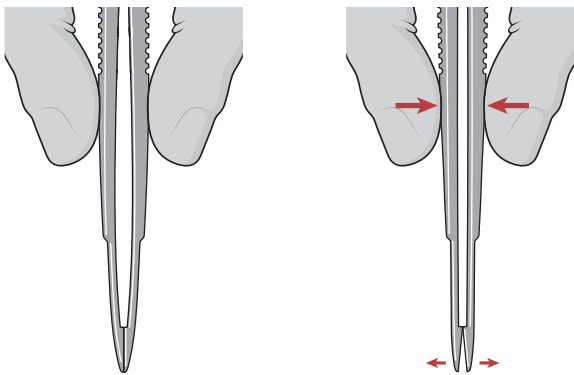

Fig. 2.14 When a proper degree of force is applied to the instrument, the tips will align properly. However, if greater forces are applied, the instrument bends and the jaws do not appose correctly

cause of their delicate tips and smooth jaws, tying forceps are ineffective for handling ocular tissues and should not be used in place of toothed tissue forceps.

2.12 Scissors

Scissors for microsuturing should be of the squeeze-handle style rather than the larger, ring-handle style. The spring mechanism of the squeeze-handle scissors allows for much greater control of the scissor tips when cutting suture under the microscope. Scissor tips may be sharp or rounded. Smaller size tips are more easily used for trimming small gauge suture knots.

Scissors with curved tips should be used with the tips curving upward to facilitate visualization of suture knots and other surrounding material that the surgeon wishes to leave intact. The ends of the suture should be cut short, and the knot should be buried in the tissue to avoid excessive irritation and an increase in vascularization (Fig. 2.15).

2.13 New Technology

With recent adoption by some surgeons of microincision (<2 mm) anterior chamber surgery, there are now available intraocular microsuturing instruments including tying forceps, tissue grasping forceps, and scissors that facilitate suturing of the iris, IOLs, and various other intraocular tissues and devices entirely within the eye (Fig. 2.16). Many of these instruments can be passed through a 2.0-mm paracentesis incision, which allows the surgeon to maintain a very stable anterior chamber while working entirely inside the eye. Multiple 1.0-mm paracenteses can be made around

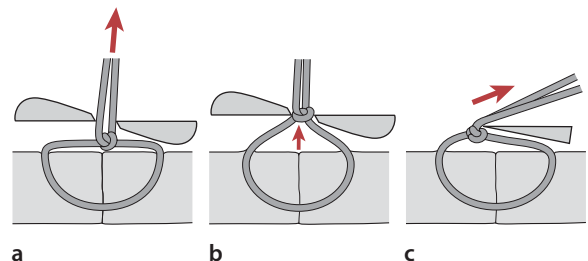

Fig. 2.15 **a** To cut the suture ends, the suture ends should be pulled up from the tissue plane, allowing the assistant to view the knot, but leaving the knot on the tissue plane. **b** If the knot is inadvertently pulled up from the tissue plane, it is more likely that the suture will be cut on the knot. **c** If the suture ends are cut with a single blade, it is best to apply tension to the thread that is being cut so that the knot is pulled up against the cutting edge of the blade. The blade should be held stationary so that the knot can be visualized

the periphery of the clear cornea to facilitate access to 360° of the anterior chamber, with use of multiple instruments and both hands. As microincision techniques continue to gain popularity with both surgeons and patients, it will become increasingly relevant for ophthalmic surgeons to incorporate the use of these effective new microinstruments into their surgical repertoire.

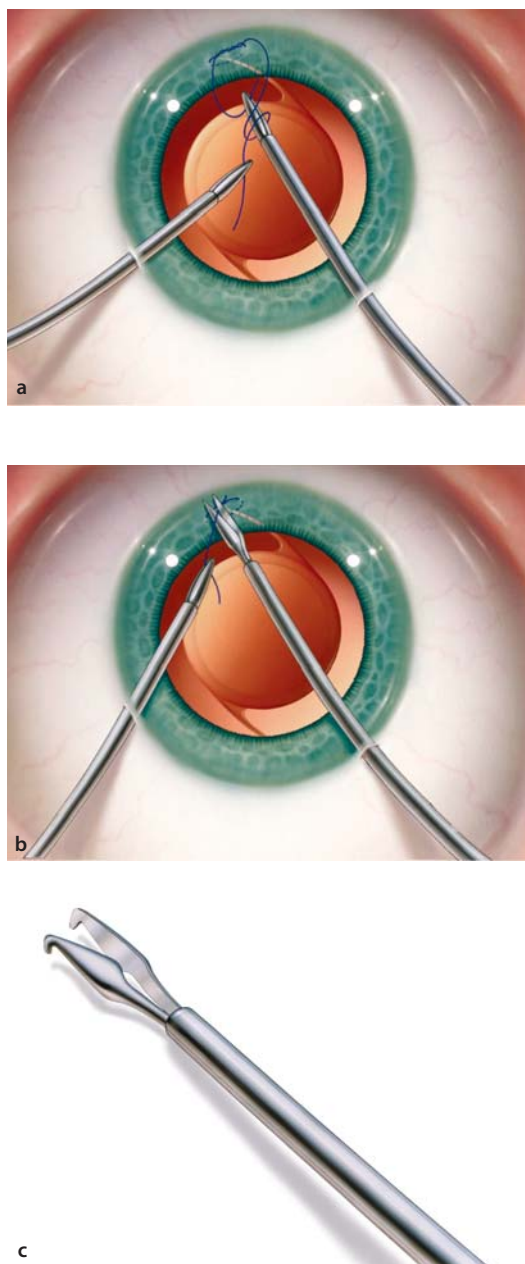

Fig. 2.16 Intraocular suturing instruments (MicroSurgical Technology). **a** Tying a suture inside the anterior chamber with two tying forceps. **b** Cutting a suture inside the anterior chamber with tying forceps and scissors. **c** Detail of grasping forceps tip

References

1. Abidin MR, Towler MA et al (1989) A new quantitative measurement for surgical needle ductility. *Ann Emerg Med*, 18(1):64–68
2. Abidin MR, Towler MA et al (1989) Biomechanics of curved surgical needle bending. *J Biomed Mater Res*, 23(A1 Suppl):129–143
3. Ahn LC, Towler MA et al (1992) Biomechanical performance of laser-drilled and channel taper point needles. *J Emerg Med*, 10:601–606
4. Altman GH, Diaz F et al (2003) Silk-based biomaterials. *Biomaterials*, 24(3):401–416
5. Aronson SB, Moore TE Jr (1969) Suture reaction in the rabbit cornea. *Arch Ophthalmol*, 82(4):531–536
6. Baimark Y, Molloy R et al (2005) Synthesis, characterization and melt spinning of a block copolymer of L-lactide and epsilon-caprolactone for potential use as an absorbable monofilament surgical suture. *J Mater Sci Mater Med*, 16(8):699–707
7. Balyeat HD, Davis RM et al (1988) Nylon suture toxicity after cataract surgery. *Ophthalmology*, 95(11):1509–1514
8. Bennett RG (1988) Selection of wound closure materials. *J Am Acad Dermatol*, 18(4 Pt 1):619–637
9. Bernstein G (1985) Needle basics. *J Dermatol Surg Oncol*, 11:1177–1178
10. Blaker JJ, Nazhat SN et al (2004) Development and characterization of silver-doped bioactive glass coated sutures for tissue engineering and wound healing applications. *Biomaterials*, 25(7–8):1319–1329
11. Blomstedt B, Jacobsson SI (1977) Experiences with polyglactin 910 (Vicryl) in general surgery. *Acta Chir Scand*, 143(5):259–63
12. Boccaccini AR, Stamboulis AG et al (2003) Composite surgical sutures with bioactive glass coating. *J Biomed Mater Res B Appl Biomater*, 67(1):618–26
13. Craig PH, Williams JA, Davis KW (1975) A biologic comparison of polyglactin 910 and polyglycolic acid synthetic absorbable sutures. *Surg Gynecol Obstet*, 141(1):1–10
14. Edlich RF, Towler MA et al (1990) Scientific basis for selecting surgical needles and needle holders for wound closure. *Clin Plast Surg*, 17:583–602
15. Edlich RF, Zimmer CA et al (1991) A new compound-curved needle for microvascular surgery. *Ann Plast Surg*, 27(4):339–344
16. Ethicon (1985) Wound closure manual. Ethicon, Somerville New Jersey, pp 1–101
17. Forrester JC (1972) Suture materials and their use. *Br J Hosp Med*, 578–592
18. Gibson T (1990) Evolution of catgut ligatures: the endeavours and success of Joseph Lister and William Macewen. *Br J Surg* 77:824–825
19. Goldenberg I (1959) Catgut, silk, and silver—the story of surgical sutures. *Surgery* 46:908–912
20. Gosset AR, Dohlman CH (1968) The tensile strength of corneal wounds. *Arch Ophthalmol*, 79:595–602
21. Halsted W (1913) Ligature and suture material. *JAMA*, 60:1119–1126
22. Herrmann JB (1971) Tensile strength and knot security of surgical suture materials. *Am Surg*, 37(4):209–217
23. Hartman LA (1977) Intradermal sutures in facial lacerations. Comparative study of clear monofilament nylon and polyglycolic acid. *Arch Otolaryngol*, 103(9):542–5433
24. Herrmann JB, Kelly RJ (1970) Polyglycolic acid sutures. Laboratory and clinical evaluation of a new absorbable suture material. *Arch Surg*, 100(4):486–490
25. Holmlund DE (1974) Knot properties of surgical suture materials. A model study. *Acta Chir Scand*, 140(5):355–62

26. Jongebloed WL, Figueras MJ (1986) Mechanical and biochemical effects of man-made fibres and metals in the human eye, a SEM-study. *Doc Ophthalmol*, 61(3-4):303-312
27. Katz LJ, Costa VP et al (1996) Filtration surgery. In: *The glaucomas, part three glaucoma therapy*. Mosby-Yearbook, Saint Louis, pp 1661-1702
28. Katz AR, Mukherjee DP et al (1985) A new synthetic monofilament absorbable suture made from poly(trimethylene carbonate). *Surg Gynecol Obstet*, 161(3):213-222
29. Kaulbach HC, Towler MA et al (1990) A beveled, conventional cutting edge surgical needle: a new innovation in wound closure. *J Emerg Med*, 8:253-63
30. Macht SD, Krizek TJ (1978) Sutures and suturing—current concepts. *J Oral Surg*, 36(9):710-712
31. Makela P, Pohjonen T et al (2002) Strength retention properties of self-reinforced poly-L-lactide (SR-PLLA) sutures compared with polyglyconate (Maxon) and polydioxanone (PDS) sutures. An in vitro study. *Biomaterials*, 23(12):2587-2592
32. Masseria V (1981) Heat treating. In: *Metals handbook*, vol 4, edn. 9. American Society for Metals, Metals Park, Ohio, pp 621-649
33. McClellan KA, Billson FA (1991) Long-term comparison of Novafil and nylon in corneoscleral sections. *Ophthalmic Surg*, 22(2):74-77
34. McClelland WA, Towler MA et al (1990) Biomechanical performance of cardiovascular needles. *Am Surg*, 56:632-8
35. Minahan PR (1914) Eyeless needle, US Patent Office, No. 1,106,667, Aug 11
36. Morgan MN (1969) New synthetic absorbable suture material. *Br Med J*, 2(652):308-313
37. Moy RL, Kaufman AJ (1991) Clinical comparison of polyglactin acid (Vicryl) and poly(trimethylene carbonate) (Maxon) suture material. *J Dermatol Surg Oncol*, 17(8):667-9
38. Moy RL, Lee A et al (1991) Commonly used suture materials in skin surgery. *Am Fam Physician*, 44(6):2123-2128
39. Moy RL, Waldman B et al (1992) A review of sutures and suturing techniques. *J Dermatol Surg Oncol*, 18(9):785-795
40. Okamura AM, Simone C et al (2004) Force modeling for needle insertion into soft tissue. *IEEE Trans Biomed Eng*, 51(10):1707-1716
41. Panilaitis B, Altman GH et al (2003) Macrophage responses to silk. *Biomaterials*, 24(18):3079-3085
42. Polack FM, *Microsurgical instrumentation and sutures*. In: (1977) *Corneal transplantation*. Grune & Stratton, New York
43. Polack FM, Sanchez J, Eve FR (1974) Microsurgical sutures. I. Evaluation of various types of needles and sutures for anterior segment surgery. *Can J Ophthalmol*, 9:42-47
44. Postlethwait RW (1970) Long-term comparative study of nonabsorbable sutures. *Ann Surg*, 171(6):892-8
45. Postlethwait RW (1970) Polyglycolic acid surgical suture. *Arch Surg*, 101(4):489-494
46. Postlethwait RW, Willigan DA et al (1975) Human tissue reaction to sutures. *Ann Surg*, 181(2):144-150
47. Ray JA, Doddi N et al (1981) Polydioxanone (PDS), a novel monofilament synthetic absorbable suture. *Surg Gynecol Obstet*, 153(4):497-507
48. Rizutti AB (1968) Clinical evaluation of suture material and needles in surgery of the cornea and lens. Ethicon, Somerville, N.J.
49. Rodeheaver GT, Nesbit WS et al (1986) Novafil. A dynamic suture for wound closure. *Ann Surg*, 204(2):193-199
50. Schechter RJ (1990) Nylon suture toxicity after vitrectomy surgery. *Ann Ophthalmol*, 22(9):352-353
51. Soong HK, Kenyon KR (1984) Adverse reactions to virgin silk sutures in cataract surgery. *Ophthalmology*, 91(5):479-483
52. Stamboulis A, Hench LL et al (2002) Mechanical properties of biodegradable polymer sutures coated with bioactive glass. *J Mater Sci Mater Med*, 13(9):843-848
53. Steinert R, (2004) *Cataract surgery*. Saunders, Philadelphia, p 52
54. Storch M, Scalzo H et al (2002) Physical and functional comparison of Coated VICRYL* Plus Antibacterial Suture (coated polyglactin 910 suture with triclosan) with Coated VICRYL* Suture (coated polyglactin 910 suture). *Surg Infect (Larchmt)*, 3 Suppl 1:S65-77
55. Stroumtsos D (1978) Perspectives on sutures. Davis and Geck, Pearl River, New York, pp 1-90
56. Swanson N, Tromovitch T (1982) Suture materials, 1980s: properties, uses, and abuses. *Int J Dermatol*, 21:373-378
57. Thacker JG, Rodeheaver GT et al (1989) Surgical needle sharpness. *Am J Surg*, 157:334-339
58. Tomihata K, Suzuki M et al (2001) The pH dependence of monofilament sutures on hydrolytic degradation. *J Biomed Mater Res*, 58(5):511-518
59. Towler MA, McGregor W et al (1988) Influence of cutting edge configuration on surgical needle penetration forces. *J Emerg Med*, 6:475-81
60. Towler MA, Tribble CG et al (1993) Biomechanical performance of new vascular sutures and needles for use in polytetrafluoroethylene grafts. *J Appl Biomater*, 4(1):87-95
61. Trier WC (1979) Considerations in the choice of surgical needles. *Surg Gynecol Obstet*, 149:84-94
62. *United States Pharmacopeia*, edn. 20 (1980) Washington, D.C.
63. van Rijssel EJC, Brand R et al (1989) Tissue reaction and surgical knots: the effect of suture size, knot configuration, and knot volume. *Obstet Gynecol*, 74:64-68
64. Yanoff M, Fine BS (1982) Surgical and non-surgical trauma. In: *Ocular pathology*. Harper and Row, Philadelphia, pp 132-138
65. Yu GV, Cavaliere R (1983) Suture materials: properties and uses. *J Am Podiatry Assoc*, 73(2):57-64